

Agent-Based Modeling: The Right Mathematics for Social Science?

Leigh Tesfatsion

Research Professor & Professor Emerita of Economics
Courtesy Research Professor of Electrical & Computer Engineering
Iowa State University, Ames, Iowa 50011-1054
[https://www2.econ.iastate.edu/tesfatsi/
tesfatsi@iastate.edu](https://www2.econ.iastate.edu/tesfatsi/tesfatsi@iastate.edu)

Keynote Address

16th Annual Social Simulation Conference (SSC 2021, Virtual)
European Social Simulation Association
20-24 September 2021

Note: Some clarifying expositional changes have been made to the originally presented slides 5-6 in response to comments/questions received from viewers of these slides.

Presentation Outline

1. Overview
2. completely **A**gent-**B**ased **M**odeling (**c-ABM**)
3. Facilitating study of critical societal Issues that cross traditional disciplinary boundaries: Two c-ABM illustrations
 - **Study 1:** Welfare-enhancing flood control for a watershed
 - **Study 2:** Customer-centric design for an electric power system
4. Bridging the “Valley of Death” between concept and practice
5. A spectrum of experimental methods for social science research:
Completely human subject  *Completely computer agent (c-ABM)*
6. Conclusion
7. Background materials (with links)

1. Overview

□ Concerns all social scientists share:

- How do real-world social systems work?
- How could real-world social systems work better?

□ Ideally, social science modeling should permit:

- Careful tailoring of models to purposes at hand
- Open-ended modeling of dynamic processes
- Matching of modeled agents to empirical referents, e.g., “human” agents should be permitted to “breathe”

2. completely Agent-Based Modeling (*c-ABM*)

- Rough Characterization: Modeling of real-world processes as open-ended dynamic systems of interacting agents

Key Features:

- Enables “historical” study of complex dynamic real-world systems as unfolding sequences of events.
- Events are fully driven by agent interactions, starting from initially-specified agent states (*culture-dish modeling*).
- Agents can be broadly specified to represent physical, biological, social, and/or institutional entities.
- Role of the modeler is restricted to the specification of *initial* agent states, and to the *non-perturbational* observation, recording, and analysis of model outcomes.

c-ABM Modeling Principles (MP1) – (MP7)

<https://www2.econ.iastate.edu/tesfatsi/ace.htm>

(MP1) Agent Definition: An **agent** is a software entity within a computationally constructed world that can affect world outcomes through expressed actions.

(MP2) Agent Scope: Agents can represent a broad range of entities, e.g., individual life-forms, social groupings, institutions, and/or physical phenomena.

(MP3) Agent Local Constructivity: An intended action of an agent at a given instant is determined by the agent's **state** (*data, attributes, and/or methods*) at this instant.

c-ABM Modeling Principles ... Continued

(MP4) Agent Autonomy: All **agent interactions** (*expressed agent actions*) at a given instant are determined by the ensemble of agent states at this instant.

(MP5) System Constructivity: The state of the world at a given instant is determined by the ensemble of agent states at this instant.

(MP6) System Historicity: Given an initial ensemble of agent states, any subsequent **world event** (*change in agent states*) is induced by prior and/or concurrent agent interactions.

(MP7) Modeler as Culture-Dish Experimenter: The role of the modeler is limited to the configuration and setting of initial agent states, and to the non-perturbational observation, analysis, and reporting of world outcomes.

c-ABM Modeling Principles ... Continued

- Models adhering to the seven c-ABM modeling principles (MP1) - (MP7) are **computational laboratories**.
 - Modelers configure and set initial agent states, but subsequent world events are driven entirely by agent interactions.
 - Thus, **modelers can be genuinely surprised** by these subsequent events.
 - c-ABM is thus **analogous to biological experimentation with cultures in Petri dishes**.

3. Facilitating study of critical societal issues that cross traditional disciplinary boundaries: Two c-ABM Illustrations

- Many critical issues facing societies today are exceedingly complex, with intertwined social and physical aspects.
- c-ABM permits researchers to model these societal issues without regard for artificial disciplinary boundaries.
 - ➔ Broader range of possible causal factors and linkages can be given *joint systematic consideration*.
- For illustration, two such c-ABM studies will briefly be reviewed.

Two Socio-Physical c-ABM Illustrations

Study 1: Welfare-Enhancing Management of a Watershed

- ➔ [1] L. Tesfatsion, C.R. Rehmann, D.S. Cardoso, Y. Jie, and W.J. Gutowski (2017), "**An Agent-Based Platform for the Study of Watersheds as Coupled Natural and Human Systems**" (*Preprint, pdf, 1.2M*), (*code/data repository*), *Environmental Modelling & Software* 89, 40-60.

TEAM: Economist; Civil Engineer; Ag Economist; Computer Scientist; Hydrologist/Climatologist

NOTE 1.1: The **c-ABM watershed platform (Java)** developed in [1] is an extended modified version of the **OpenDanubia platform (Java)** developed by Barthel et al. (*Env. Modelling & Software* 23, 2008, 1095-1121) for the study of climate change impacts on the Upper Danube watershed in Germany.

NOTE 1.2: The **particular watershed test case reported in [1], and summarized below**, was undertaken as the first step in an *Iterative Participatory Modeling (IPM)* process conducted with watershed stakeholders.

Study 2: Customer-Centric Design of an Electric Power System

- ➔ [2] S. Battula, L. Tesfatsion, Z. Wang (2020), "**A Customer-Centric Approach to Bid-Based Transactive Energy System Design**" (*WP Version, pdf, 1.7MB*), *IEEE Transactions on Smart Grid* 11(6), 4996-5008

TEAM: Electrical & Computer Engineer; Economist; Electrical & Computer Engineer

Illustrative Study [1]

Welfare-Enhancing Management of a Watershed

Empirical Anchor

loway Creek Watershed,
Central Iowa

(Known as **Squaw Creek Watershed** prior to 2020)

Outlined in purple 

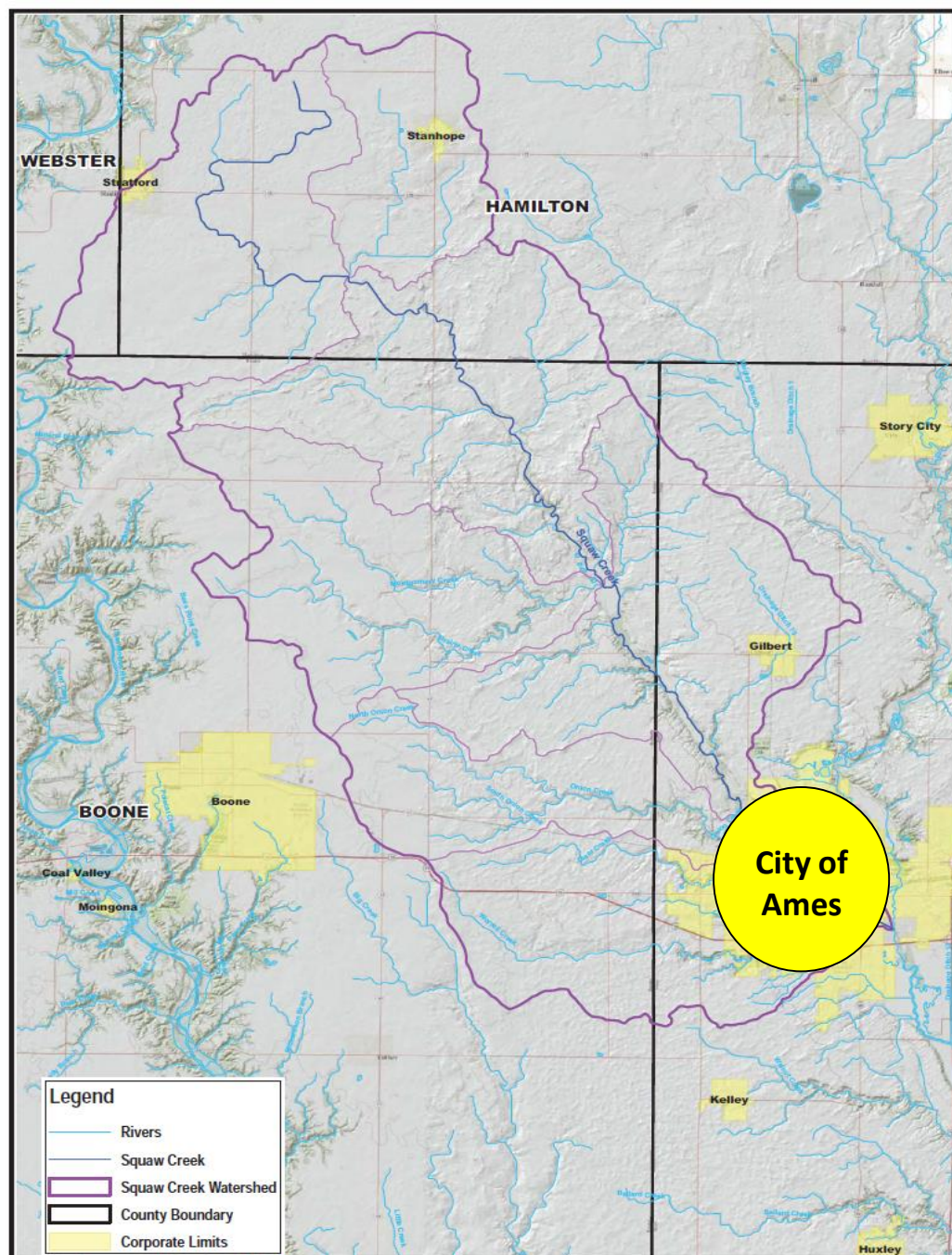

Study [1]: Overview

■ Approach

Develop a c-ABM watershed platform permitting study of coupled interactions among hydrology, climate change, & strategic human behavior over time

■ Empirical Anchor: Ioway Creek Watershed (Central Iowa)

- **Single basin** consisting of **upstream farmland** and a **downstream city (Ames)**.
- **Randomly fluctuating precipitation & market prices** affect **cropland planting & yields**.
- **Farmland water run-off** contributes to **downstream city flood damage**.
- **Farmers can reduce run-off** by setting aside potential cropland as “water-retention land” with natural coverage; **but this reduces potential farmer profits** from crop sales.
- **City Manager can budget subsidies for farmers** to increase set-aside of water-retention land; **but this reduces budget monies available for city levee investment & city services**.

■ Normative Social Design Question: Incentive Alignment

Does there exist a budget-allocation policy for the City Manager that aligns **city** goals & constraints with **farmer** goals & constraints?

Study [1]: Agent Hierarchy for the Watershed World

(Down-arrows denote “has a” relations; up-arrows denote “is a” relations)

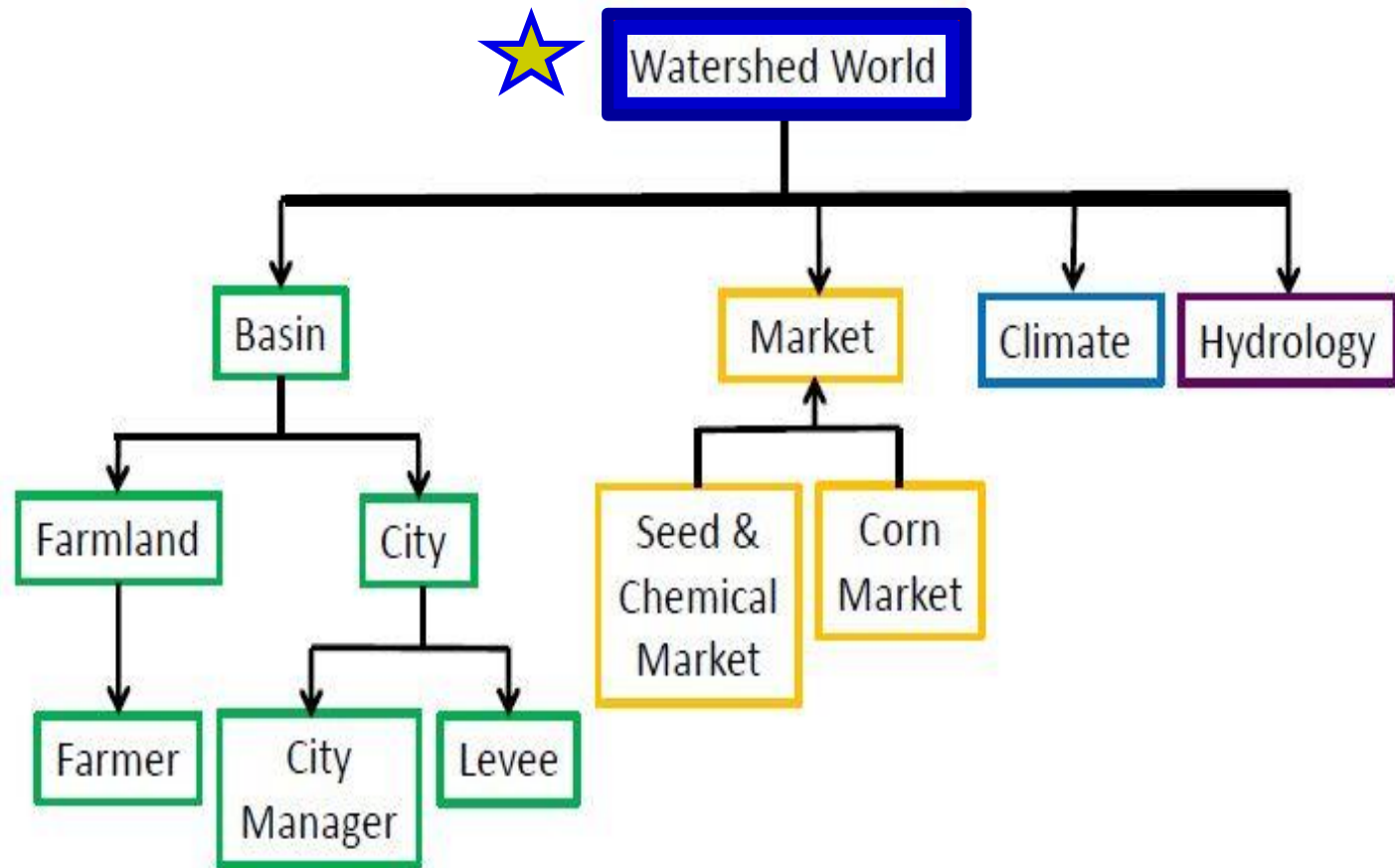

The Watershed World is implemented by the **WACCShed (Water and Climate Change Watershed) Platform**, an open-source Java platform developed by Y. Jie, D.S. Cardoso, W.J. Gutowski, C. Rehmann, and L. Tesfatsion (2013-2014) at ISU. **Code/Data Repository:** <https://bitbucket.org/waccproject/waccshedsoftwareplatform>

Study [1]: Agent Actions and Interactions

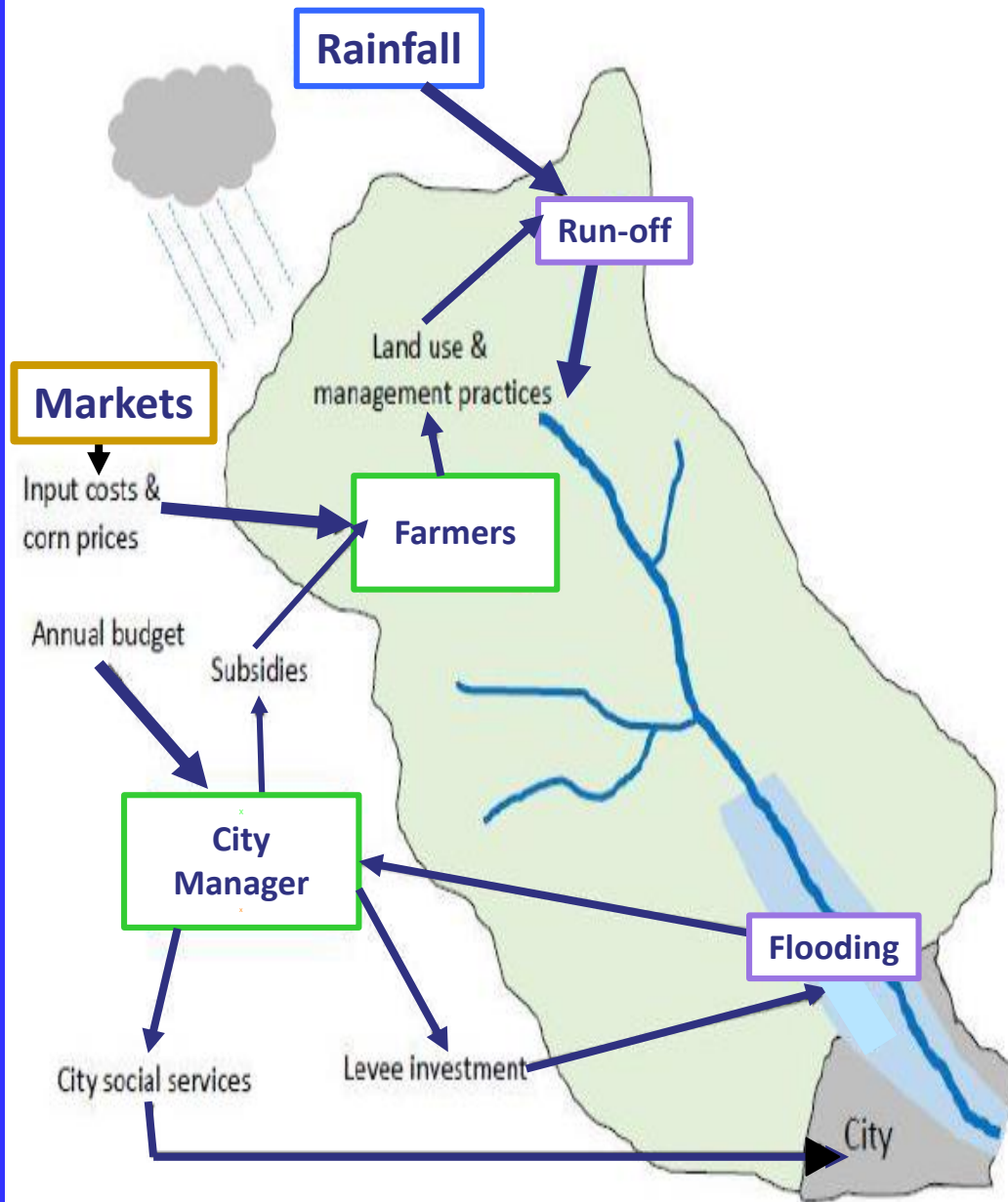

Decision-Making “Human” Agents

Corn Farmers (annual allocation of land, corn planting & harvesting, and consumption & savings);

City Manager (annual allocation of budget, Farmer subsidy payouts).

Physical Agents (Data Driven)

Basin (population, land attributes, ...)

Climate (20-year hourly rainfall pattern)

Hydrology (HEC-HMS, Feldman et al. 2000)

Maps farmer land allocations

+ land attributes (e.g., curve numbers)

+ rainfall (hourly depth in inches)

→ Water discharge rate into city
(which affects extent of city flood damage)

Institutional Agents (Data Driven)

Markets (cost/price data)

→ Annual input planting cost (\$/acre) and retail corn price (\$/bushel).

Study [1]: Experimental Design

□ Empirically-Based Probability Distribution (S,P) for Scenarios:

- A scenario set S was constructed consisting of 31 climate/market scenarios s , each 20 years in length with an associated probability $P(s)$. This construction was based on loway Creek Watershed data (1997-2013) for rainfall, seed costs, fertilizer costs, and retail corn prices.
- The 31 scenarios were numbered -15, -14, ..., -1, 0, +1, +2, ..., +14, +15, based on their Hamming signed-distance from a “normal” (typical) scenario “0”.
- The resulting probability distribution (S,P) is depicted below:

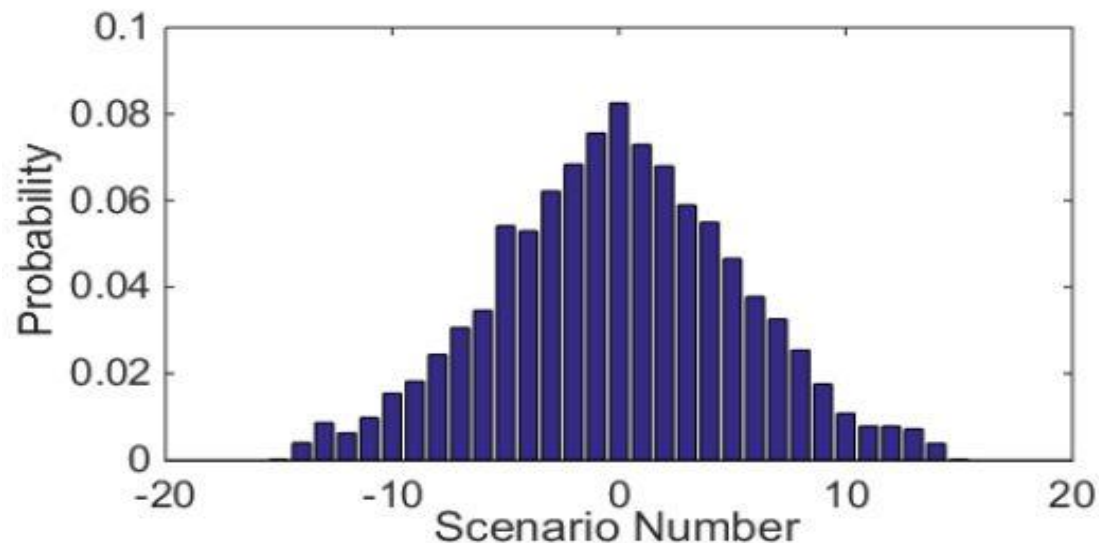

□ **City Manager (Stackelberg Game Leader):** In February of each year t the City Manager allocates the city budget among city services, levee investment, and farmer subsidies for water-retention land set-aside, **taking into account the effects of these subsidies on farmer land allocations in March.**

— **City Manager's Goal: Allocate city budget to maximize expected value of City Social Welfare** =: $[city\ social\ services] + \psi [city\ flood\ damage\ mitigation]$

□ **Three Types of Treatment Factors:**

1. **Farmer decision method, Risk Neutral or Risk Averse:** For allocation of farmland among cropland, fallow land, & water-retention land in March of each year t ;
2. **Levee quality effectiveness LQE, Low or High:** Affects extent of city flood damage resulting from water discharge into city from January through October of each year t ;
3. **Farmer annual savings target θ^0 , Low, Moderate, or High:** End-of-year savings for each year t are carried over as initial money holdings for year $t+1$.

□ **For each tested treatment-factor configuration:**

Thirty-one watershed runs were generated, one for each climate/market scenario s in S . Each run consisted of 20 simulated years. The resulting farmer welfare & city social welfare outcomes are reported in two forms:

1. Expected form, using the empirically-based probability distribution (S,P) ;
2. Differentiated by environmental scenario ($s = -15, \dots, -1, 0, 1, \dots, +15$)

Study [1]: Illustrative Test Case

- **One farmer F**, with savings target $\theta^0 \geq 0$ & subsistence consumption $C^{\text{sub}} > 0$
- **Two different land-allocation methods are tested for farmer F**

Method 1. Farmer F is risk neutral (i.e., F does not consider outcome variance)

In March of each year t , after seed/fertilizer costs become known and City Manager has announced a water-retention land subsidy rate, F selects a land allocation to **maximize expected consumption EC_t for t** , subject to savings $S_t \geq \theta^0$ and consumption $C_t \geq C^{\text{sub}}$.

F then buys inputs and plants corn. If realized rainfall/corn prices for t later result in $C_t < C^{\text{sub}}$ for t (even if F reduces realized savings for t to 0), then F must exit watershed.

Method 2. Farmer F is risk averse (i.e., F does consider outcome variance)

In March of each year t , after seed/fertilizer costs become known and City Manager has announced a water-retention land subsidy rate, F selects a land allocation to **maximize expected utility-of-consumption $EU(C_t)$ for t** , subject to savings $S_t \geq \theta^0$ and consumption $C_t \geq C^{\text{sub}}$. F has a strictly concave utility function $U(C) = \log(C - C^{\text{sub}} + D)$, where $D > 0$.

➔ Given any expected consumption for t , *F's expected utility-of-consumption $EU(C_t)$ for t* depends on the *variation* of F's consumption $C_t(s_t)$ across the scenarios s_t in $S_t = \{\text{set of possible scenarios for years } \tau \geq t, \text{ given history up to } t\}$. **All else the same as Method 1.**

Study [1]: Total Farmer Welfare Results. Realized across 20 simulated years for different settings (θ^0 , LQE), differentiated by scenario s

Farmer is **Risk Neutral**

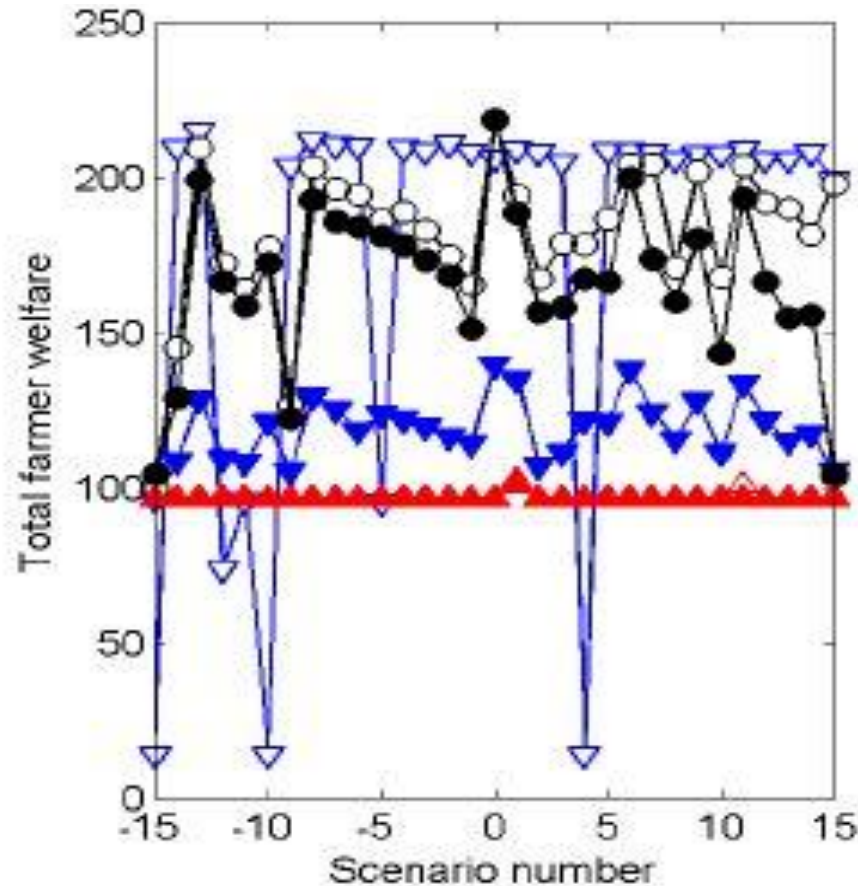

Farmer is **Risk Averse**

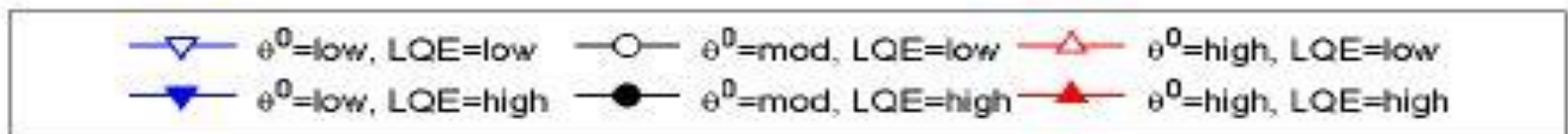
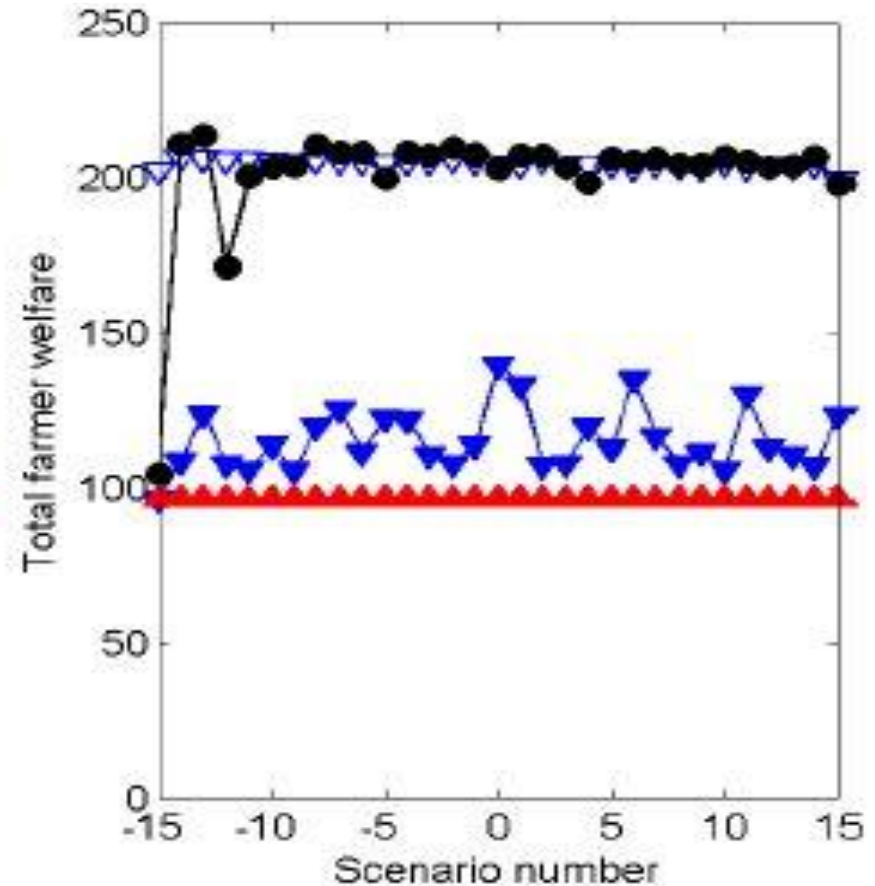

Study [1]: Total City Social Welfare Results. Realized across 20 simulated years for different settings (θ^0 , LQE), differentiated by scenario s

Farmer is **Risk Neutral**

Farmer is **Risk Averse**

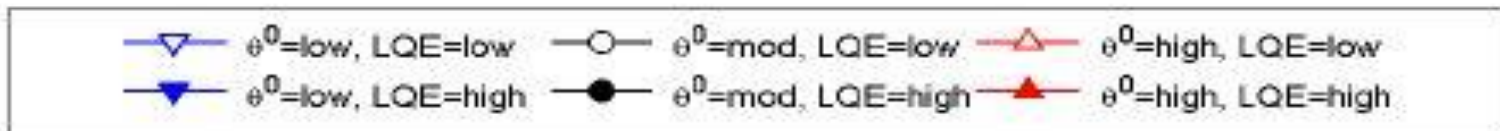
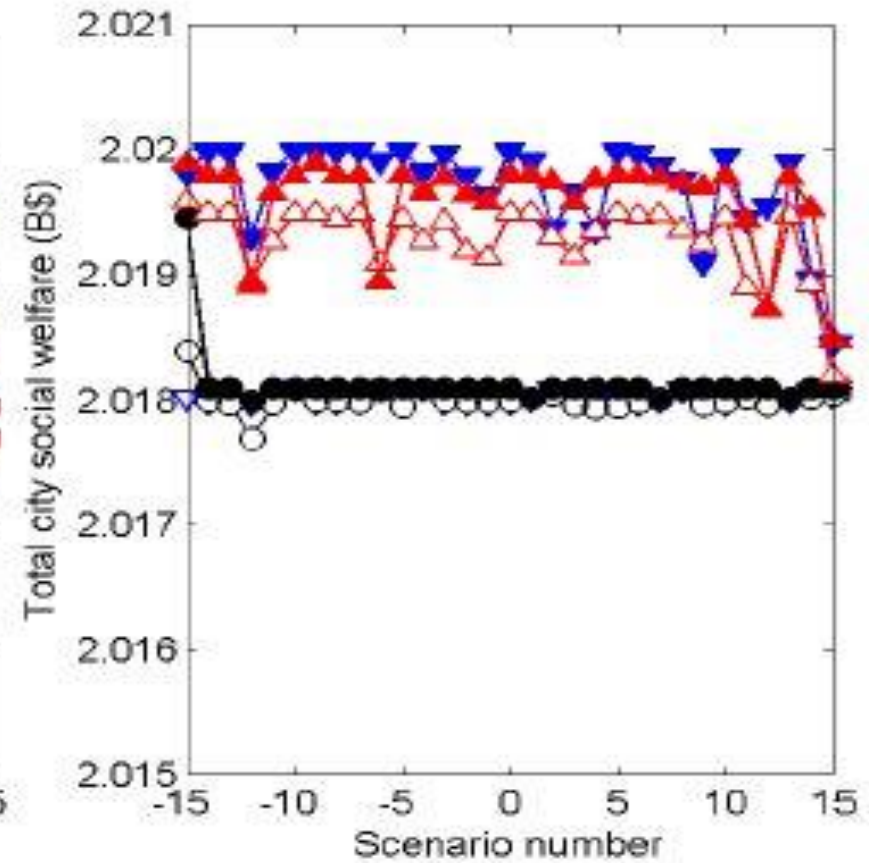
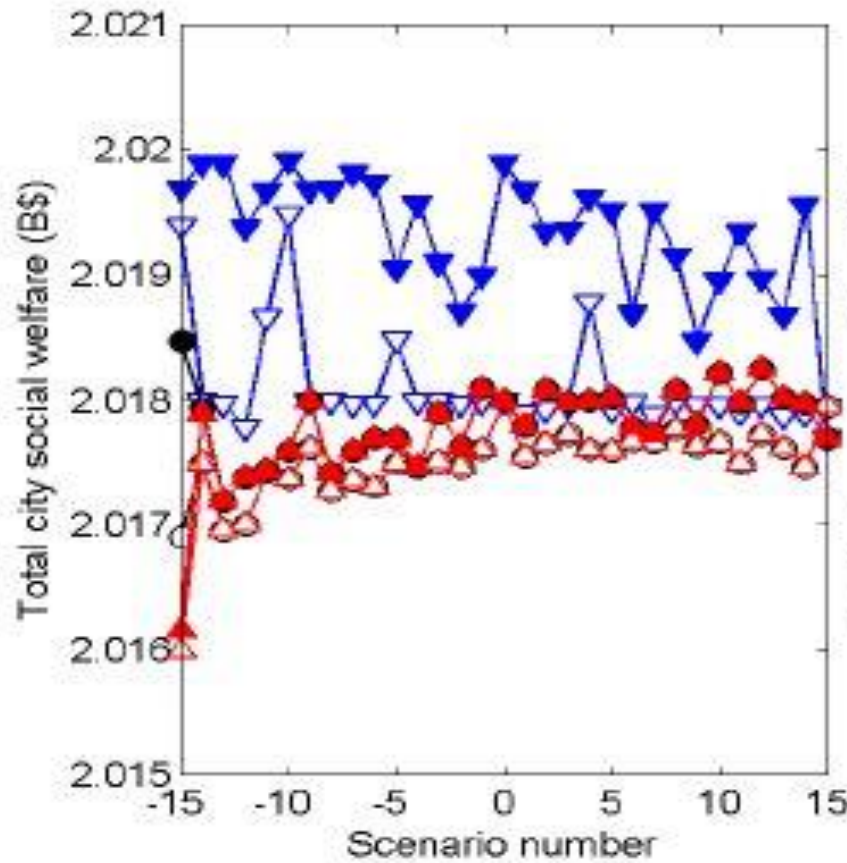

Study [2]: Customer-Centric Design of an Electric Power System

(Battula, Tesfatsion, & Wang, 2020, *IEEE Transactions on Smart Grid*)

□ Motivated by three premises

1. **Electric power systems are increasingly dependent on renewable power resources (wind, solar, ...) with uncertain volatile generation.**
2. **To ensure system efficiency & reliability,** power demand and power supply must be in continual balance
 - for wholesale power transactions, supported by the transmission network;
 - and for retail power transactions, supported by the distribution network.
3. **To ensure customer welfare,** customer goals/constraints need to be aligned with system efficiency/reliability constraints without violating customer privacy.

One promising way forward:

Market-based **Transactive Energy System (TES)** designs for integrated transmission and distribution systems that:

- permit ancillary balancing-support services to be contractually procured from customers with controllable electrical devices;
- permit decentralized implementations that respect customer privacy.

Study [2]: Empirical Anchor

U.S. regions with centrally-managed wholesale electric power systems

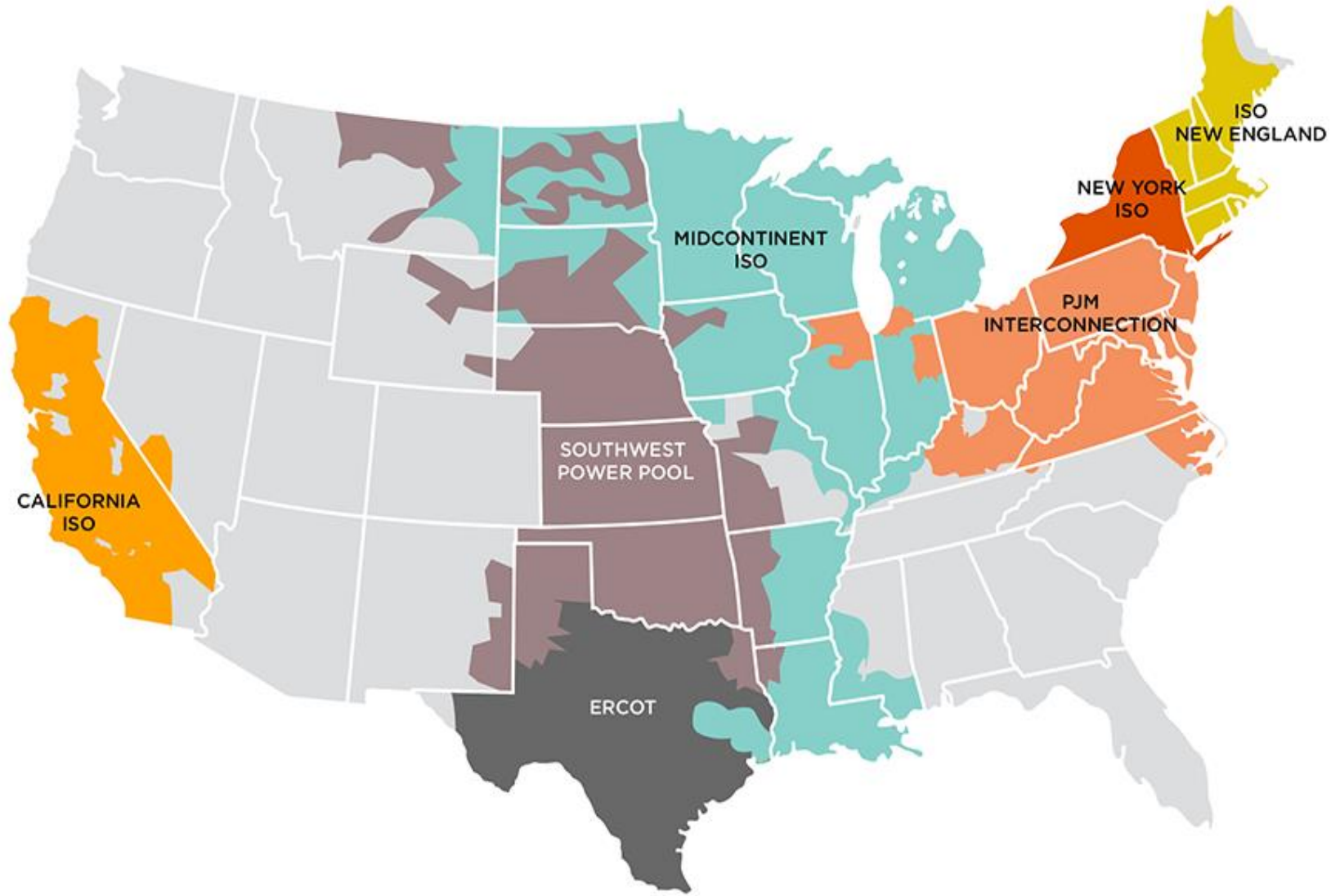

Study [2]: Illustrative ITD Household Test Case

Integrated **T**ransmission and **D**istribution (**ITD**) system for which:

- (i) A 123-node distribution network is populated by 927 households;
- (ii) Each household has a **H**eating, **V**entilation, & **A**ir-**C**onditioning (**HVAC**) system;
- (iii) Each HVAC system is smartly controlled (i.e., responsive to price signals)
- (iv) The 123-node distribution network is linked to an 8-node transmission network

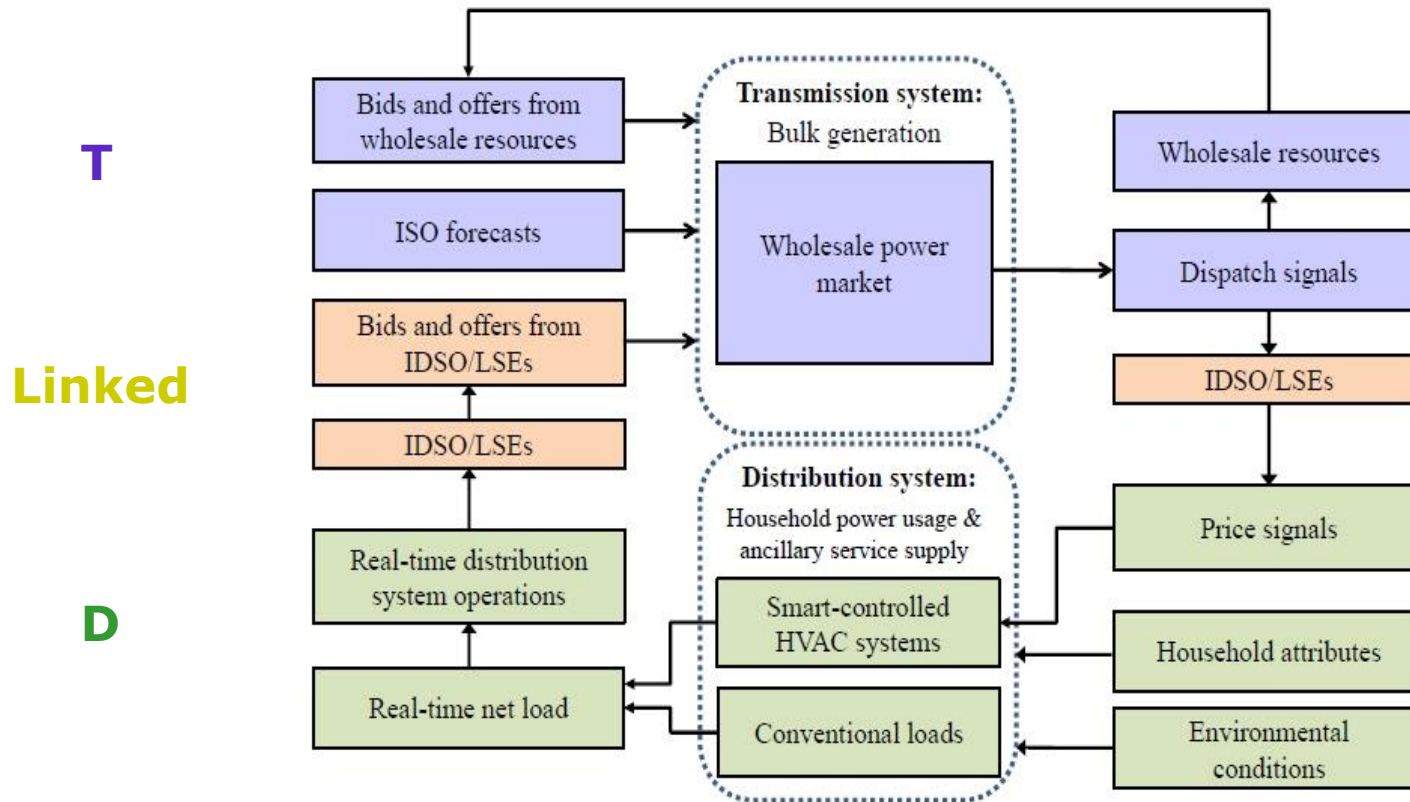

IDSO = Independent **D**istribution **S**ystem **O**perator (manages distribution system)

LSE = **L**oad-**S**erving **E**ntity (submits retail customer power demands into wholesale power market)

Study [2] ITD Household Test Case: Agent Hierarchy for ITD System

(Down-arrows denote “has a” relations; up-arrows denote “is a” relations)

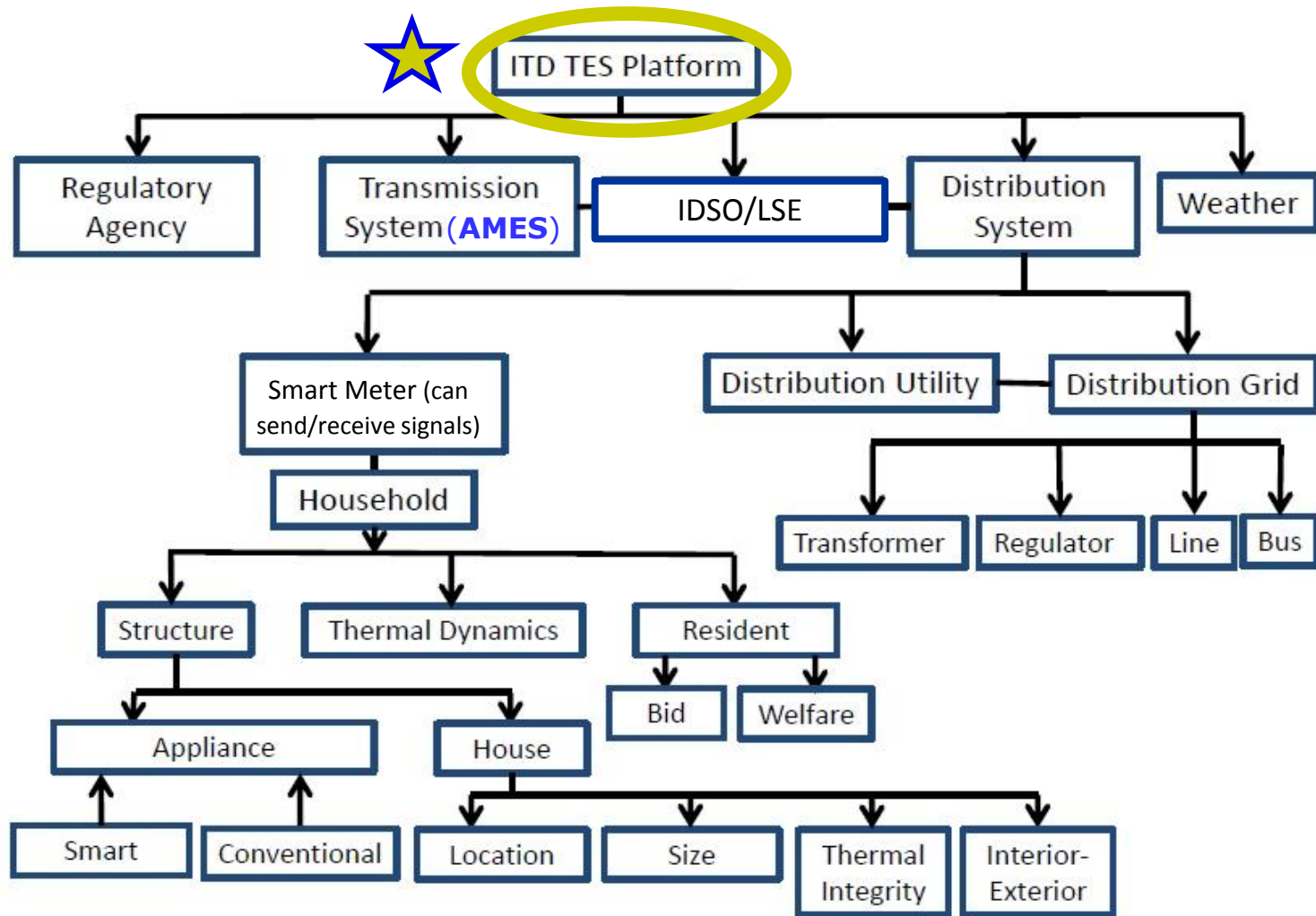

The **ITD TES Platform V2.0** is an open-source co-simulation platform, developed by S. Battula & L. Tesfatsion (2019-2021) with support from Pacific Northwest National Laboratory (PNNL) and Department of Energy (DOE).

GitHub Code/Data Repository: <https://github.com/ITDProject/ITD TES Platform>

Study [2] ITD Household Test Case: Agent Hierarchy for Transmission System (Down-arrows denote “has a” relations; up-arrows denote “is a” relations)

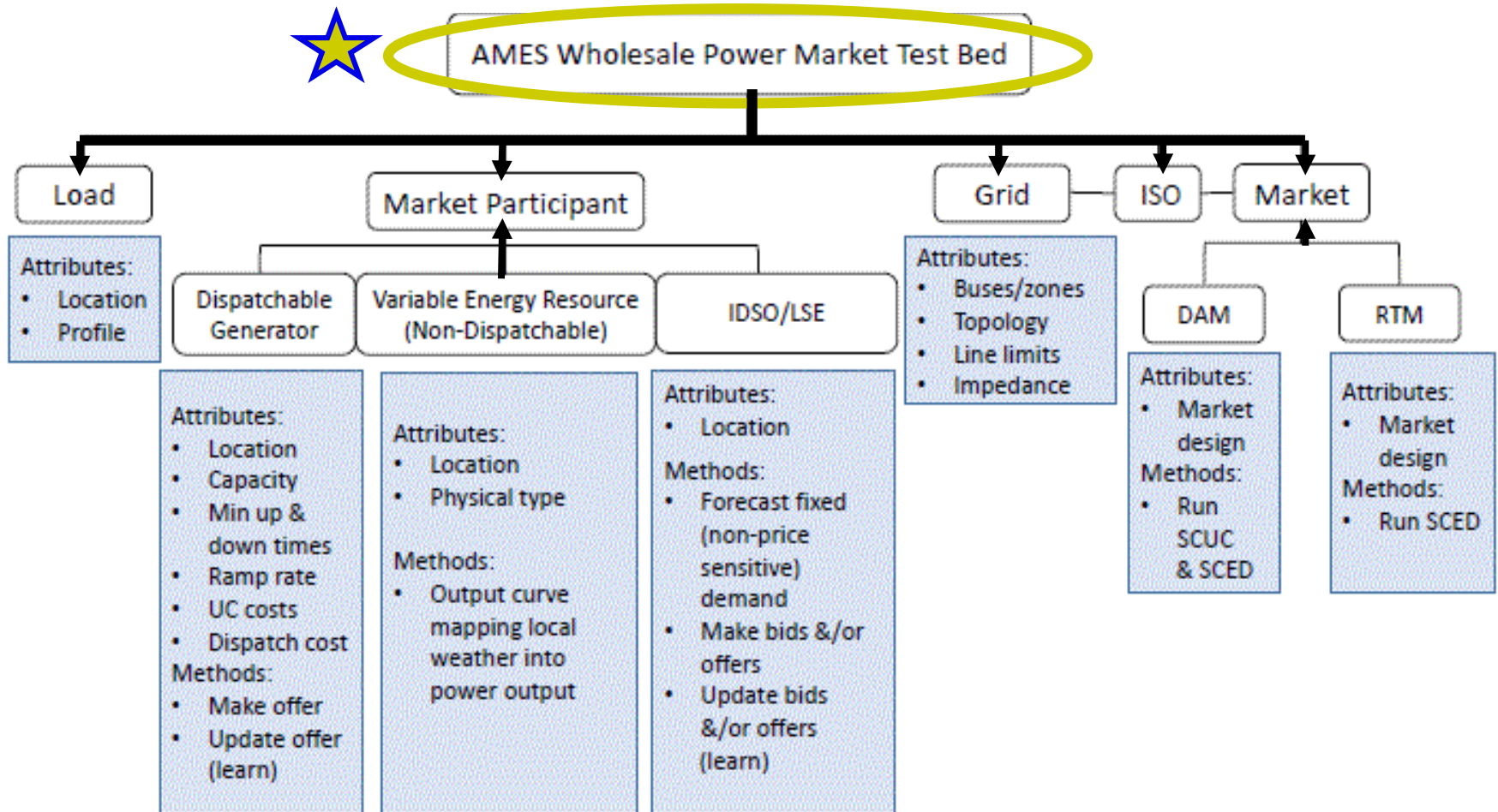

AMES (Agent-based Modeling of Electricity Systems) V5.0 is an open-source java/python platform, developed by S. Battula and L. Tesfatsion (2019-2021) with support from PNNL and DOE.

GitHub Code/Data Repository: <https://github.com/ames-market/AMES-V5.0>

ITD TES Platform V2.0: Key Co-Simulated Software Components (Specialized below to implementation of ITD Household Test Case)

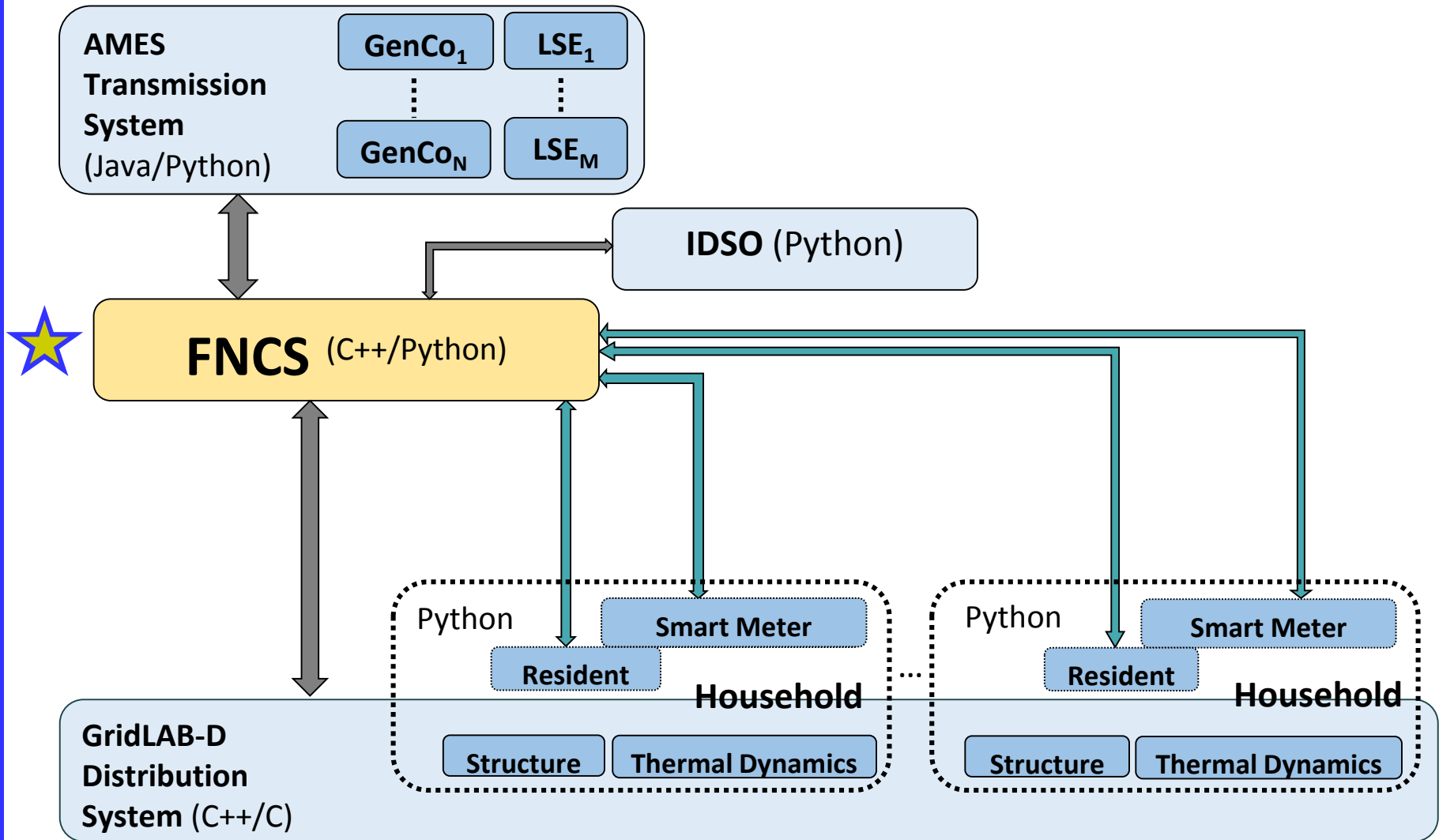

 **FNCS** = *Framework for Network Co-Simulation*, developed at PNNL (2011-2016)

Study [2] ITD Household Test Case: Transmission Network

8-Node Transmission Network Based on Data for the Texas Energy Region (ERCOT)

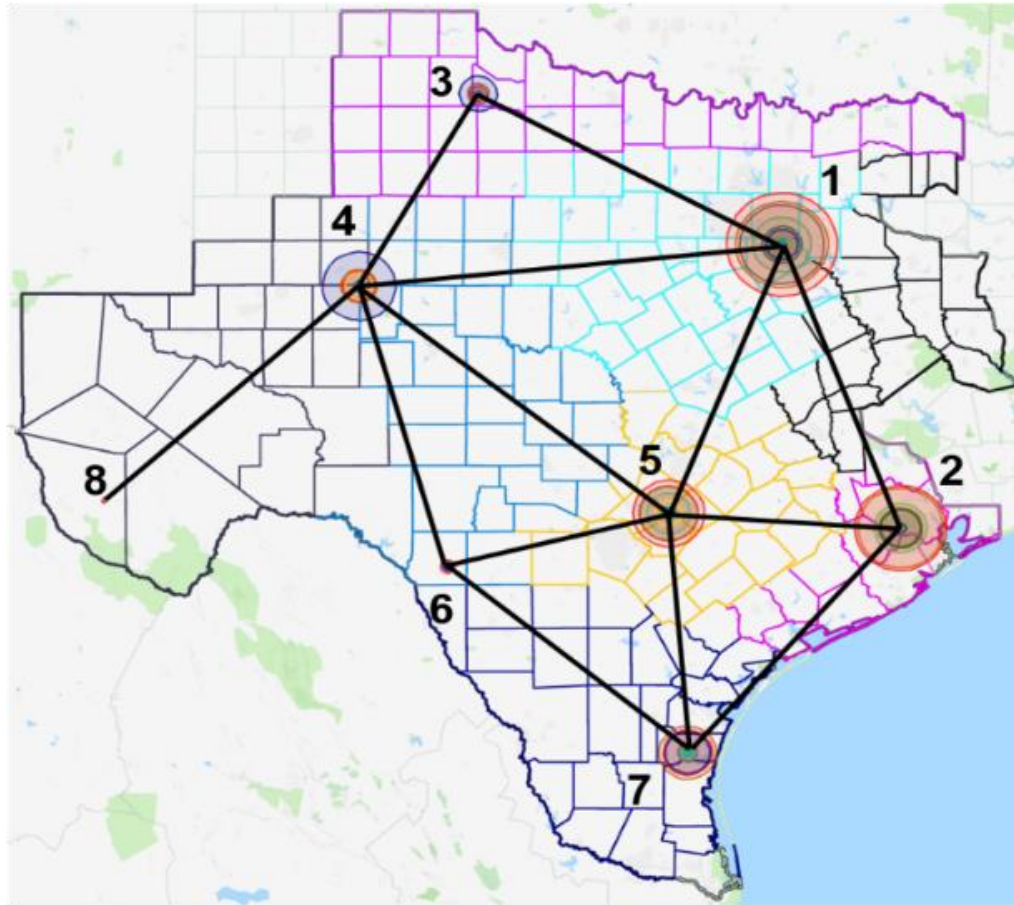

- This 8-Node transmission network was generated using a synthetic grid construction method developed by Tom Overbye & collaborators (Texas A&M University).
- This method is included in the **ERCOT Test System**, an open-source java/python platform, implemented in part by AMES V5.0, that was developed by S. Battula and L. Tesfatsion (2019-2020) with support from PNNL and DOE.
- **Code/Data Repository:** <https://github.com/ITDProject/ERCOTTestSystem>

Study [2] ITD Household Test Case: Transmission Network ... Continued

Schematic Depiction of 8-Node ERCOT Transmission Network

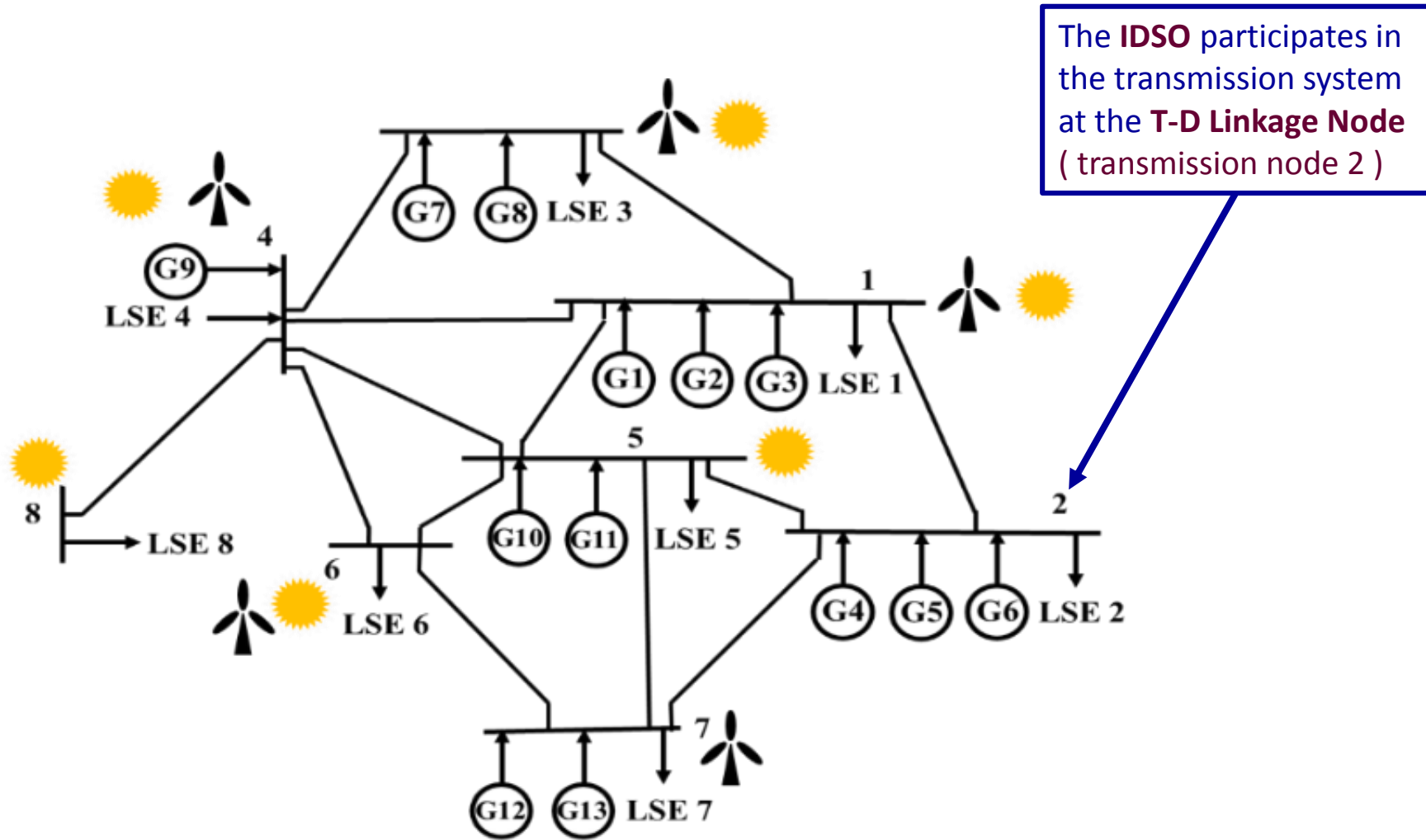

The depicted 8-node ERCOT transmission network includes distributed wind power (🌬️), solar power (☀️), and thermal generation (G).

Study [2] ITD Household Test Case: Distribution Network

(123-node distribution network populated by 927 households: IEEE 123)

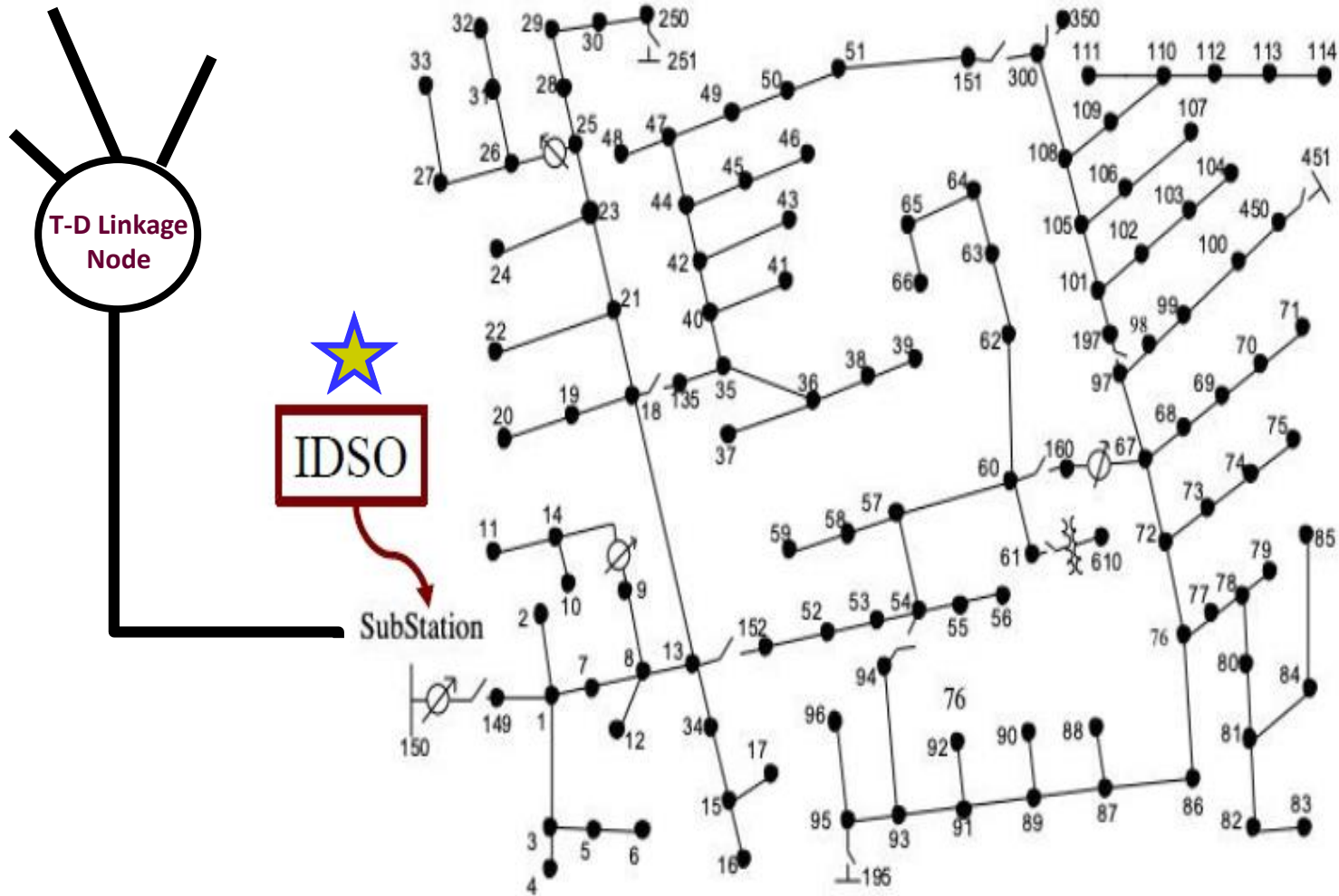

The **IDSO** participates in the distribution system at the **SubStation** (distribution node 150), which is electrically connected to the **T-D Linkage Node** (transmission node 2).

Study [2] ITD Household Test Case: Two-Way Communication Network

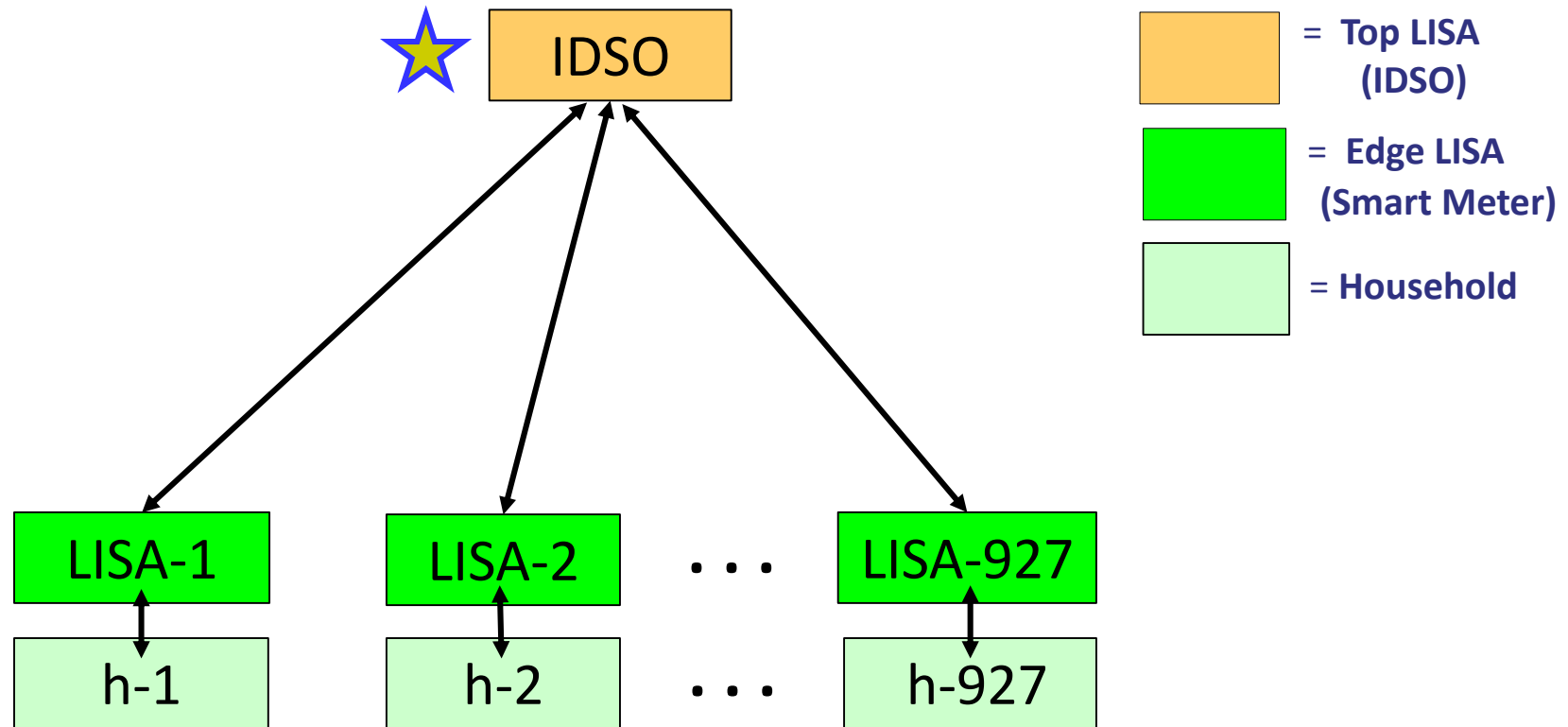

★ The **Independent Distribution System Operator (IDSO)** is the top-level **Local Intelligent Software Agent (LISA)** in a two-way LISA communication network with 927 “Edge LISAs”. An Edge LISA is a smart meter for one of the 927 households connected to the 123-node distribution network on depicted Slide 27.

Study [2] ITD Household Test Case:

Five-Step TES Design Consisting of Five Iterated Steps

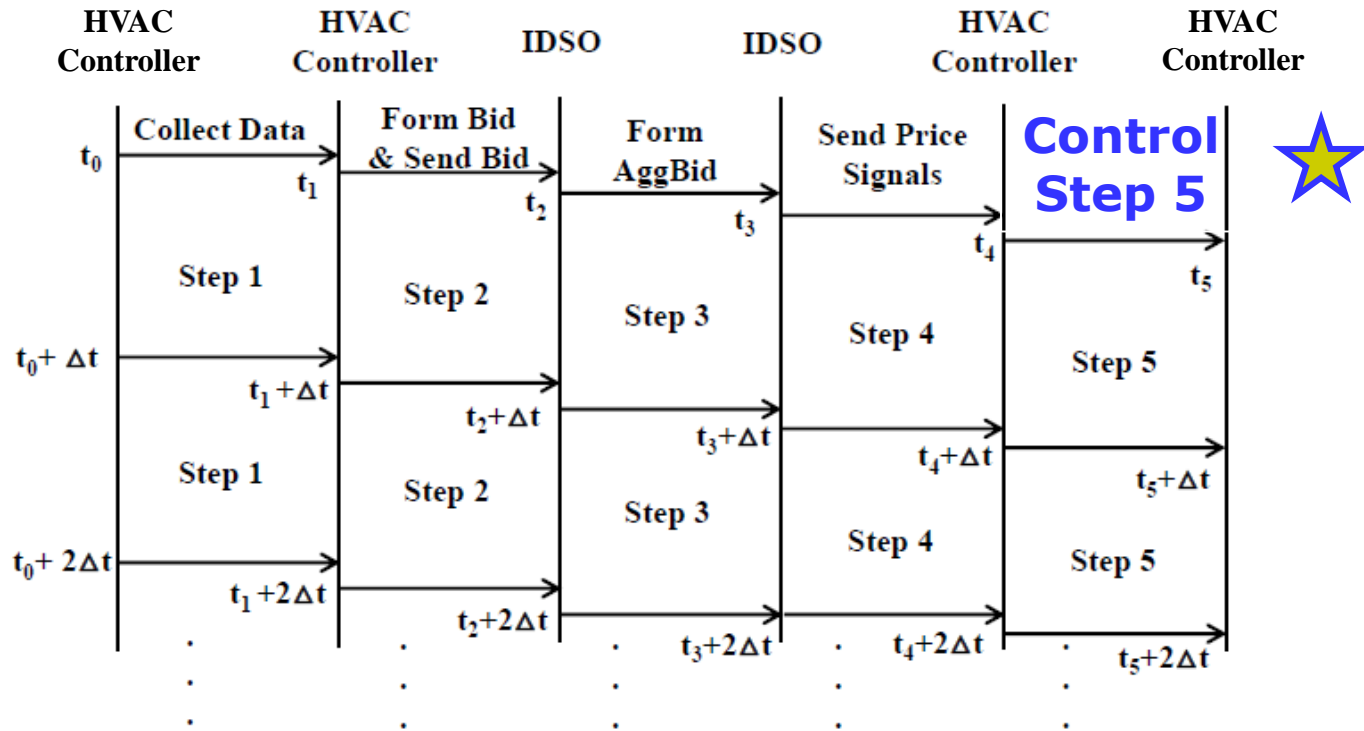

At start of **Control Step 5** the HVAC smart-controller for each household h either turns (or keeps) h 's HVAC system **ON at power level $P = P^*(h) > 0$** or **OFF at power level $P = 0$** , depending on the price signal the IDSO communicated to h in Step 4.

The Five-Step TES Design is an example of an IDSO-managed bid-based TES design.

Study [2] ITD Household Test Case: General State-Conditioned Form of Each Household's Optimal Bid Function

Supply function for "ancillary service"
= "IDSO-dispatchable power absorption"

Demand function for power usage

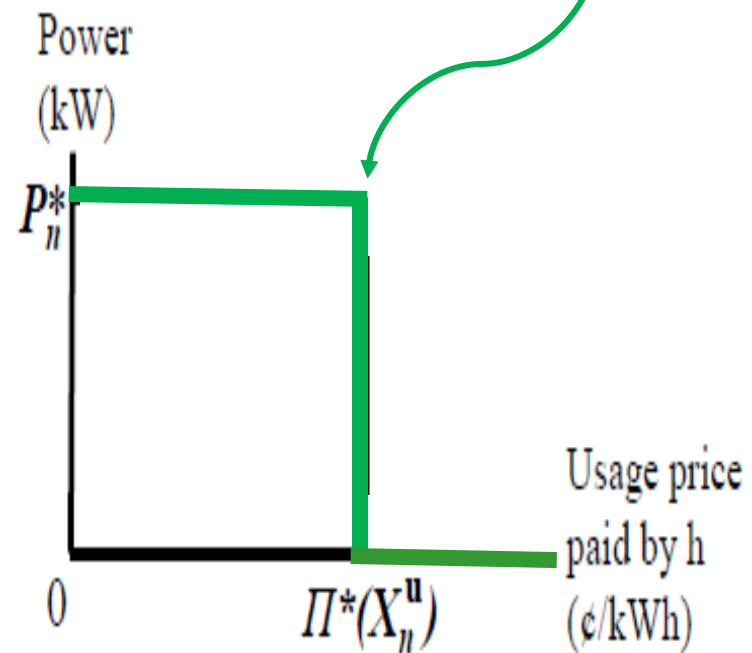
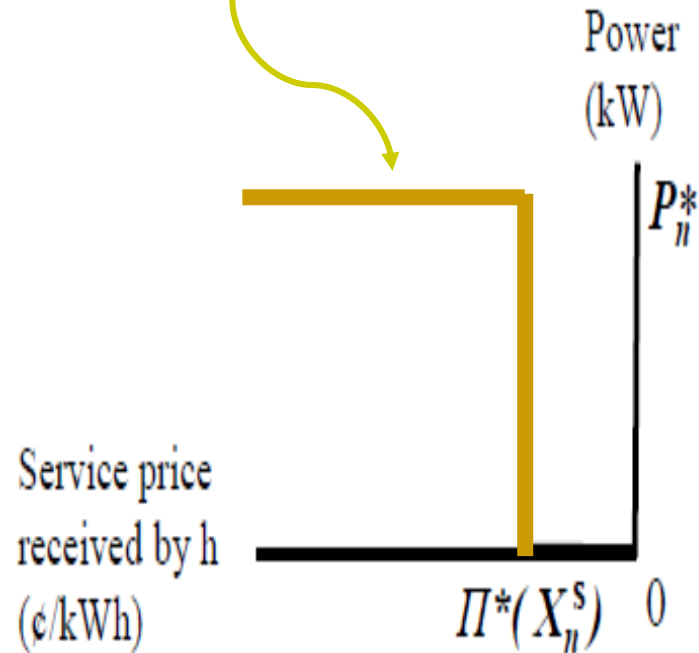

(a) General optimal bid form for Household h when h is in an *ancillary service state*
(negative price \rightarrow h receives payment for ancillary service)

(b) General optimal bid form for Household h when household h is in a *power usage state*
(positive price \rightarrow h pays for power usage)

Technical Note: In Step 2 of the Five-Step TES design, the HVAC smart-controller for each household h:

- automatically constructs h's optimal bid function for Control Step 5, as a function of h's attributes and current state;
- fully communicates this bid function to IDSO in the form of two real numbers (Π^* , P^*), where: Π^* =: cut-off price signed either "+" (power usage) or "-" (service); and P^* =: the ON power usage of h's HVAC system.

Study [2] ITD Household Test Case:

Illustrative IDSO Load-Matching Experiments for the Five-Step TES Design

- The IDSO Target Load Profile for Day D+1 = *IDSO's *day-ahead forecast* for household hourly net power withdrawal at T-D Linkage Node 2 during Day D+1.*
- The IDSO submits this day-ahead forecast as a **power demand bid** into day-ahead wholesale power market conducted on Day D to try to ensure sufficient power is available at T-D Linkage Node 2 during Day D+1 to cover household hourly net power withdrawals at this node during Day D+1.
- **IDSO Matching Goal for the Five-Step TES design on Day D+1:**
Realized* household hourly net power withdrawal at T-D Linkage Bus 2 during day D+1 **should match the IDSO's power demand bid.*
- **The IDSO selects this goal in order to hedge against price risk on Day D+1:**
If total household net power withdrawal at T-D Linkage Node 2 **realized** on Day D+1 is **different** than the IDSO's **Day-D forecast** for this withdrawal – as indicated by the IDSO's Day-D power demand bid -- then the IDSO must either pay (for extra power withdrawal) or be paid (for reduced power withdrawal), where payments are calculated using whatever real-time market prices happen to be realized on Day D+1.

Study [2] ITD Household Test Case: IDSO Load-Matching Example 1

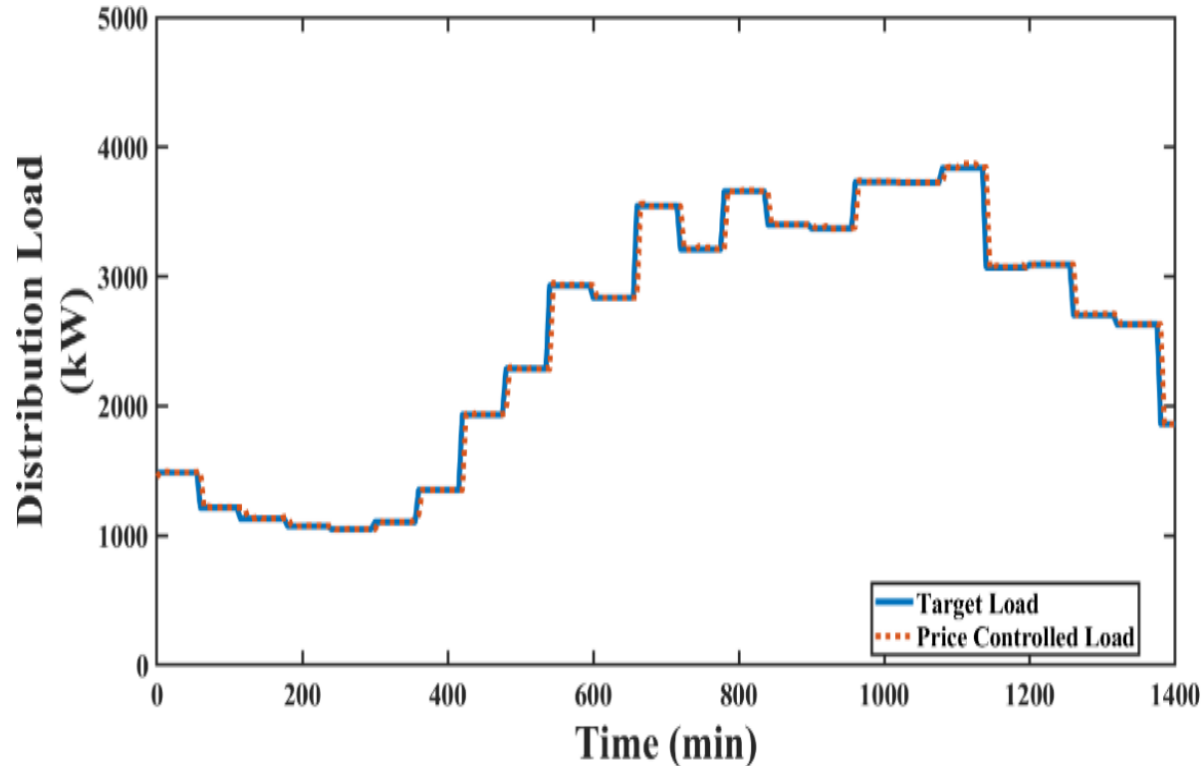

Example 1: IDSO Load-Matching Results for Operating Day D+1 = 1440 min. Source: [2, Fig. 5]

- In each 5-step iteration, the IDSO uses the bid functions received from households in Step 2 to determine retail prices in Steps 3–4.
- The IDSO then signals these retail prices to households at the beginning of Control Step 5.

RESULT: The price-controlled actual total household power withdrawal at T-D Linkage Node 2 during Day D+1 closely matches the IDSO target load profile for Day D+1.

Study [2] ITD Household Test Case: IDSO Load-Matching Example 1 ... Continued

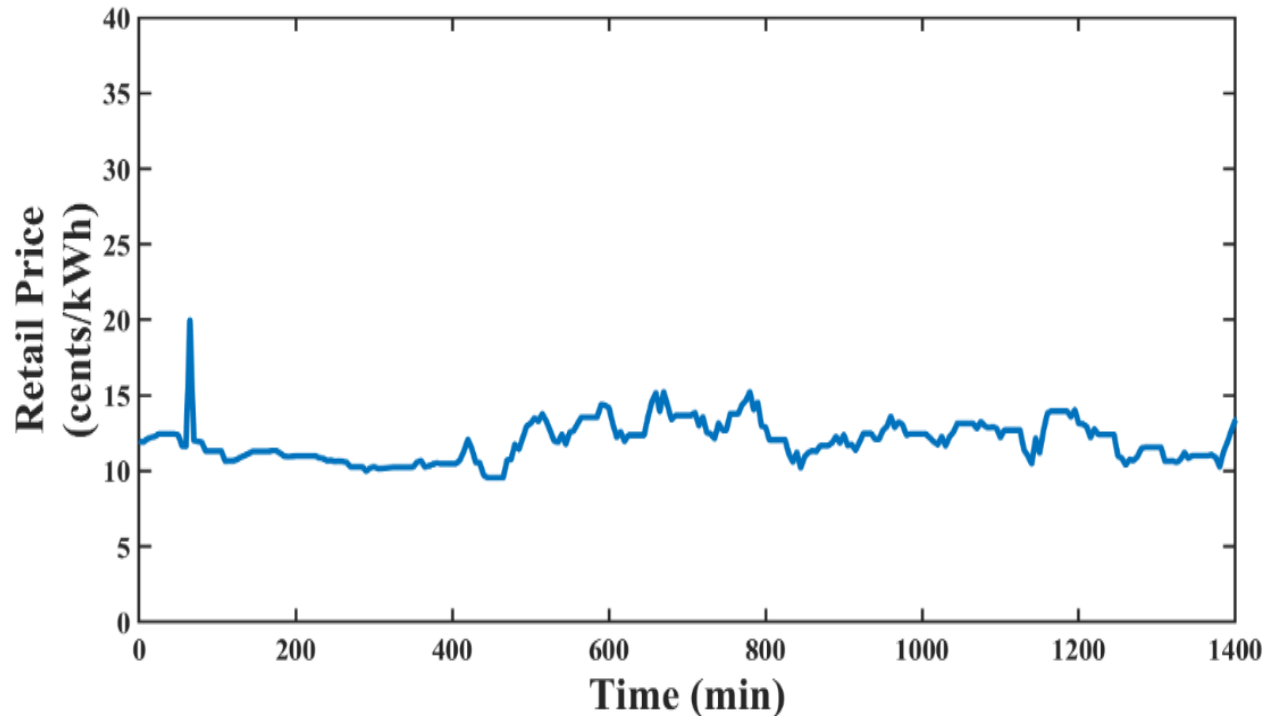

Example 1: Retail Prices Set by IDSO for Operating Day D+1 = 1440 min. Source: [2, Fig. 6]

- The figure reports the positive retail prices communicated by the IDSO at the beginning of each Control Step 5 during Day D+1 to all households in a power usage state. The IDSO uses the household bid functions received in Step 2 to determine these retail prices.
- Households in ancillary service state receive no price signals from IDSO during Day D+1, indicating IDSO does not need to buy ancillary service during Day D+1 to achieve its goal.

Study [2] ITD Household Test Case: IDSO Load-Matching Example 2

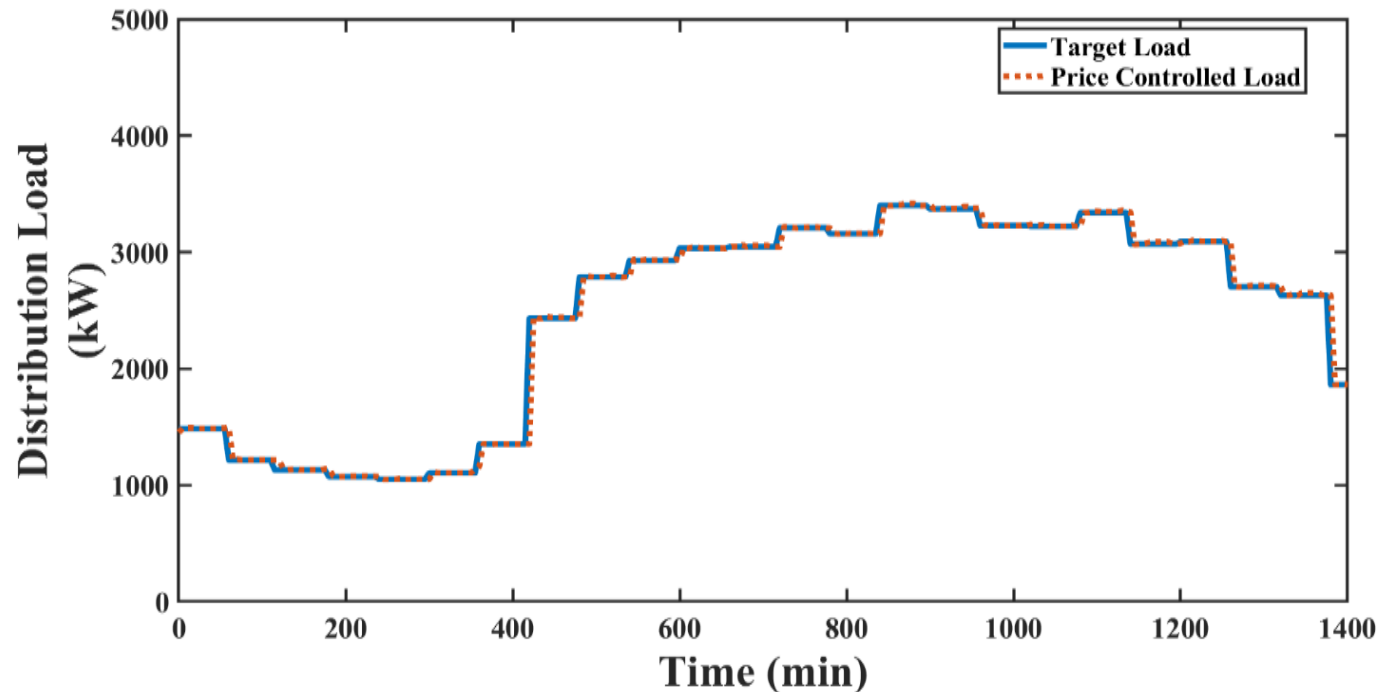

Example 2: IDSO Load-Matching Results for Operating Day D+1 = 1440 min.

Source: [L. Tesfatsion et al. (2021), PSERC Final Report, Project #M-40, 2021, Fig. 1.32]

- In each 5-step iteration, the IDSO uses the bid functions received from households in Step 2 to determine retail price signals in Steps 3–4.
- The IDSO then signals these retail prices to households at the beginning of Control Step 5.

RESULT: As in Example 1, the price-controlled actual total household power withdrawal at T-D Linkage Node 2 during Day D+1 closely matches the IDSO target load profile for Day D+1.

Study [2] ITD Household Test Case: IDSO Load-Matching Example 2 ... Continued

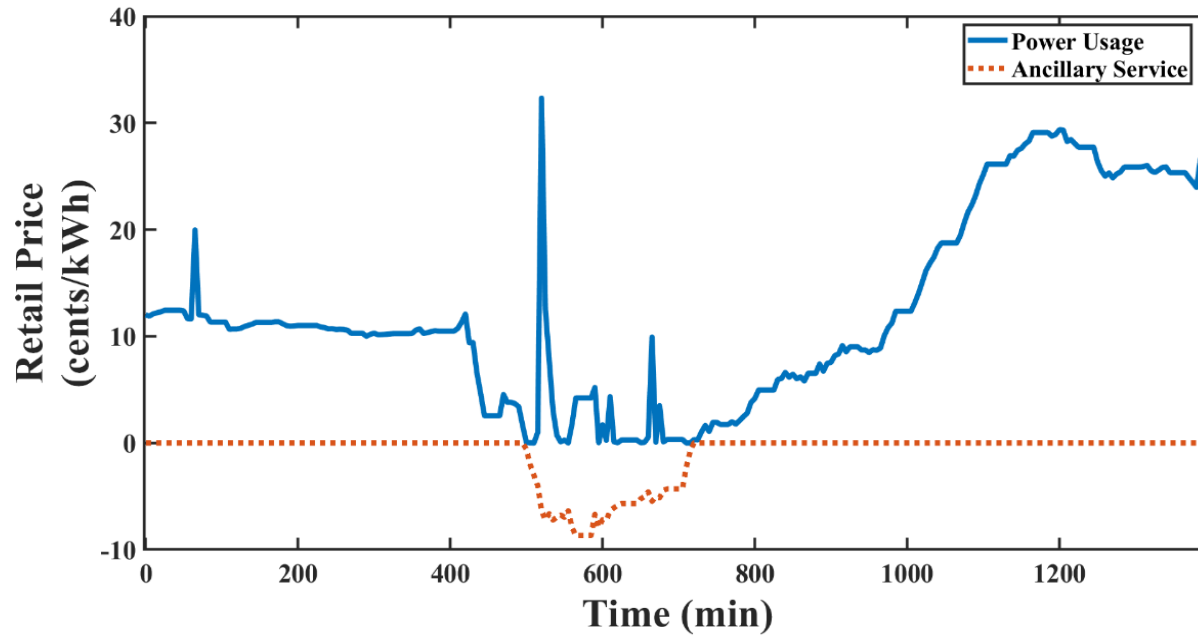

Example 2: Retail Prices Set by IDSO for Operating Day D+1 = 1440 min.

Source: [L. Tesfatsion et al. (2021), PSERC Final Report, Project #M-40, 2021, Fig. 1.33]

- **As in Example 1**, during most of Day D+1 the IDSO signals strictly positive retail prices to households in a power usage state, indicating the IDSO is selling power to these households.
- **However, in contrast to Example 1**, during some hours of Day D+1 the IDSO now finds it must signal strictly negative retail prices to households in an ancillary service state to enable achievement of its load-matching goal.
- These strictly negative retail prices indicate the IDSO is buying ancillary service (power absorption) from households in an ancillary service state.

4. Bridging the “Valley of Death” Between Concept and Practice

- 4.1 c-ABM facilitates comprehensive empirical validation
- 4.2 c-ABM enables progression from small-scale conceptual modeling to large-scale field/pilot studies
- 4.3 c-ABM supports *Iterative Participatory Modeling (IPM)*
- 4.4 c-ABM aids development of standardized presentation protocols for social design research

4.1 c-ABM facilitates comprehensive empirical validation: EV1 – EV4

<https://www2.econ.iastate.edu/tesfatsi/EmpValid.htm>

EV1. Input Validation

Are the exogenous inputs for a model empirically meaningful and appropriate for the purpose at hand?

Exogenous Input Examples: Initial state conditions, functional forms, shock realizations, data-based parameter estimates, &/or parameter values imported from other studies

EV2. Process Validation

- Do modeled physical, biological, institutional, & social processes reflect real-world aspects important for purpose at hand?
- Are all process specifications consistent with essential scaffolding constraints, such as physical laws, stock-flow relationships, and accounting identities?

EV3. Descriptive Output Validation:

How well are model-generated outputs able to capture salient features of the sample data that was used for model identification?
(in-sample fitting)

EV4. Predictive Output Validation:

How well are model-generated outputs able to forecast distributions or distribution moments either for sample data that have been withheld from model identification, or for new data acquired later?
(out-of-sample forecasting)

4.2 c-ABM enables progression from small-scale conceptual modeling to large-scale field/pilot studies

- Implementation of social designs should proceed only after careful empirically-based testing.

Examples: Institutions, programs, policies, ...

- Ensuring that a design is ready for implementation will typically require a series of modeling efforts at different scales, and with different degrees of empirical validation.
- Moving too soon to design implementation entails a major risk of adverse unintended consequences.

Standardized Design Readiness Levels (DRLs)

DRL-1: Conceptual design idea

DRL-2: Analytic formulation

DRL-3: Low-fidelity small-scale modeling

DRL-4: Moderate-fidelity small-scale modeling

DRL-5: High-fidelity small-scale modeling

DRL-6: Prototype small-scale modeling (reflects expected field conditions apart from scale)

DRL-7: Prototype large-scale modeling (reflects expected field conditions)

DRL-8: Field study

DRL-9: Real-world implementation

Basic research
carried out at
universities...

**Valley of
Death**

Government,
business,
regulatory
agencies ...

Valley of Death: DRLs 4-6

- Infrequency of studies at DRLs 4-6 hinders development of social designs from

Concept → *Implementation*

- c-ABM is well suited for bridging this “Valley of Death”
 - c-ABM computational platforms enable systematic testing of design performance at DRLs 4-6.

4.3 c-ABM Supports *Iterative Participatory Modeling (IPM)*

IPM for Complex Social Design Problems:

- Researchers & stakeholders repeatedly cycle through **Design Readiness Levels (DRLs)** 1-9 in an ongoing open-ended learning process
- In each cycle, c-ABM platforms can help ensure progression through the Valley of Death (DRLs 4-6).
- **Goal:** Continual improvement rather than the attempted delivery of a “definitive solution”

4.4 c-ABM aids development of standardized presentation protocols for social design research

- How can c-ABM-supported studies of social designs at successively higher DRLs be clearly presented to stakeholders, regulators, and other researchers?
- **Proposal:** Develop a standardized sequence of DRL-conditioned presentation protocols.

Example: Extend “one size fits all” ODD protocol for ABM to a sequence ODD-1, ODD-2, ... of ODD protocols in parallel with the design readiness levels DRL-1, DRL-2, ...

ODD = **O**verview, **D**esign concepts, and **D**etail

(Volker Grimm et al., 2006, *Ecological Modelling*, v. 198, 115–126)

5. A Spectrum of Experimental Methods for Social Science Research

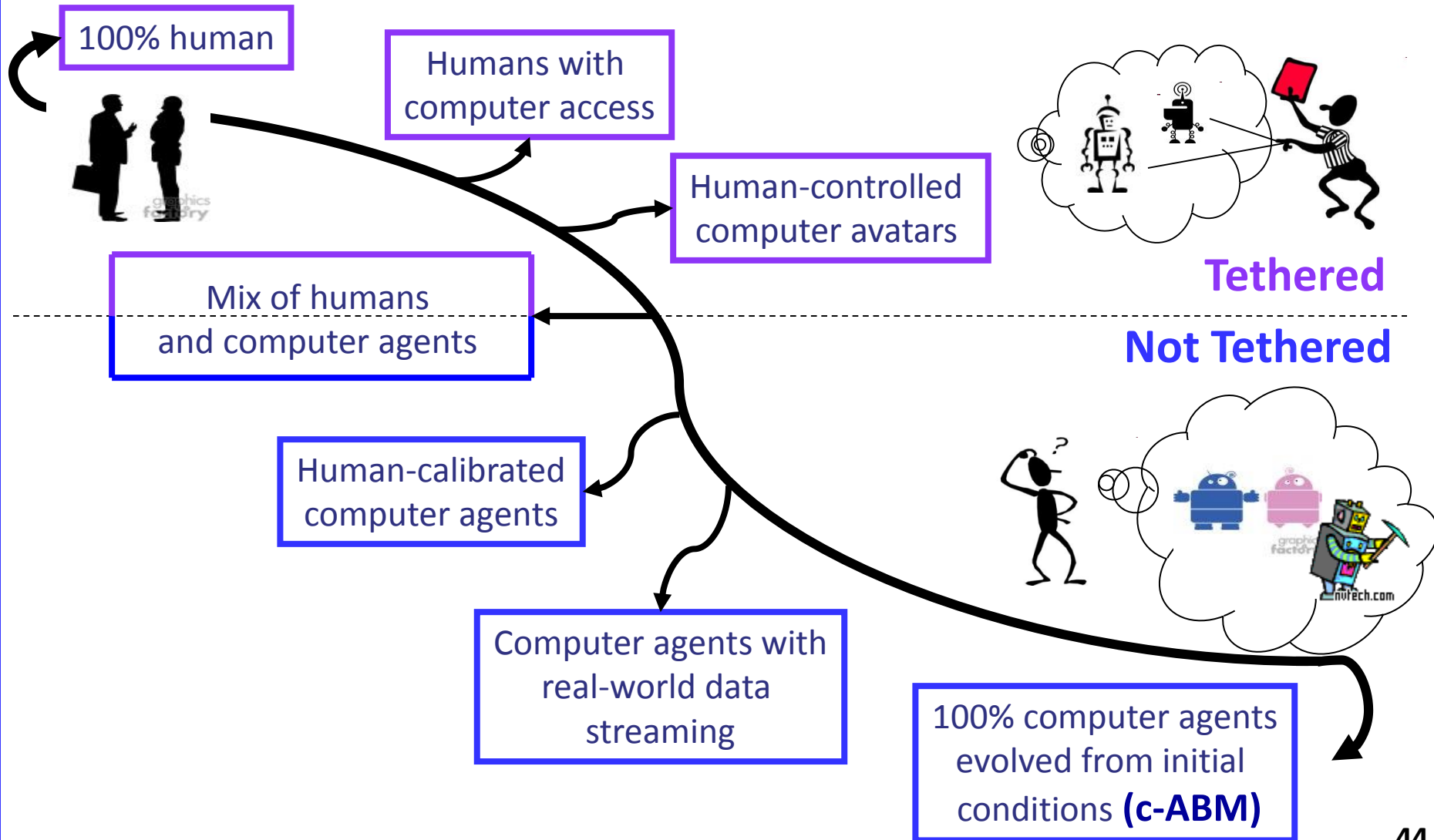

6. Conclusion

- **The seven modeling principles characterizing c-ABM are designed to mimic biological experimentation with cultures in Petri dishes.**
 - c-ABM permits societal processes to be modeled and studied as dynamically unfolding events, starting from modeler-specified initial conditions.
 - Agents (physical, biological, social, institutional,...) can be closely tailored to actual empirical referents.
 - The **c-ABM completeness requirement** -- *dynamics must be entirely driven by interactions among agents that actually “reside within the modeled world”* -- should help discourage modelers from relying on *ad hoc* exogenous “shock terms” as the sources of dynamic persistence and/or the drivers of dynamic interactions.

- **c-ABM facilitates comprehensive bottom-to-top empirical validation**

- Input Validation
- Process Validation
- Descriptive Output Validation (in-sample fitting)
- Predictive Output Validation (out-of-sample forecasting)

Analytical tractability is no longer a valid justification for simplifications that distort reality in ways important for the purpose at hand.

- **Prediction:** As real-world processes become more automated, hence more dependent on computer bots (agents) for implementation, this will profoundly impact empirical validation:

Validation of Process Representation  Exact Process Replication

6. Conclusion ... Continued

❑ c-ABM can help to bridge the “Valley of Death.”

c-ABM platforms, especially in co-simulated form, can help bridge the gap between

- the *relatively small-scale conceptual modeling* typically carried out at universities, and
- the *much larger-scale field/pilot studies* typically required by businesses and governments as a prerequisite for real-world implementation.

❑ Last but not least, c-ABM can break down artificial disciplinary boundaries.

As illustrated for *watersheds* and *electric power systems*:

- Co-simulated c-ABM platforms permit teams of researchers from traditionally separated social science and physical science disciplines to address critical societal issues involving complex interactions among social and physical processes.

7. Background Materials (With Links)

- [3] **Agent-Based Computational Economics: A Completely Agent-Based Modeling Approach**
<https://www2.econ.iastate.edu/tesfatsi/ace.htm>
- [4] **On-Line Guide for Newcomers to Agent-Based Modeling in the Social Sciences**
<https://www2.econ.iastate.edu/tesfatsi/abmread.htm>
- [5] **Empirical Validation of c-ABM Models**
<https://www2.econ.iastate.edu/tesfatsi/EmpValid.htm>
- [6] **Presentation Protocols for c-ABM Models**
<https://www2.econ.iastate.edu/tesfatsi/amodguide.htm>
- [7] L. Tesfatsion (2017), “**Modeling Economic Systems as Locally-Constructive Sequential Games,**”
J. of Economic Methodology, Vol. 24, Issue 4, pp 384-409
https://lib.dr.iastate.edu/econ_workingpapers/23
- [8] **c-ABM Modeling of Coupled Natural and Human Systems**
<https://www2.econ.iastate.edu/tesfatsi/aagric.htm>
- [9] L. Tesfatsion (2018) , “**Electric Power Markets in Transition: Agent-Based Modeling Tools for Transactive Energy Support**” ([Preprint](#)), Ch. 13 (pp. 715-766) in C. Hommes & B. LeBaron (Eds.), *Handbook of Computational Economics 4: Heterogeneous Agent Models*, Handbooks in Economics Series, North Holland (Elsevier), Amsterdam, the Netherlands.